



SCRANTON
PRODUCTS
DESIGNED TO BE WORRY-FREE

make your
RESTROOM
THE BEST ROOM

your **INDUSTRY** LEADER

Hiny Hiders Partitions – Color: Titanium, Texture: Orange Peel
Configuration: Floor Mounted Overhead Braced, Height: 55” Standard Panels & Doors
Vanities, Urinal Screens, Tufftec Benches – Color: Grey
Tufftec Lockers – Color: Blueberry

With over 25 years of experience, Scranton Products is the industry leader in plastic bathroom partitions and lockers. Constructed from premium, American-made solid plastic, our products resist dents, scratches, corrosion, graffiti and mildew.

When you purchase Scranton Products, you are investing in peace of mind. With unmatched durability and an array of designer colors and textures, Scranton Products installs confidence in every product.



**SCRANTON
PRODUCTS®**
DESIGNED TO BE WORRY-FREE



DESIGNED TO BE WORRY-FREE

our **FAMILY** OF PRODUCTS



 **ECLIPSE
PARTITIONS™**
PRIVACY BY DESIGN

PARTITIONS

Patent Pending



 **HINY
HIDERS®**
STYLE THAT LASTS AND LASTS

VANITIES



**URINAL
SCREENS**



**SHOWER
DIVIDERS**





**DURALIFE
LOCKERS®**

BUILT FOR THE LONG HALL

LOCKERS



**TUFFTEC
LOCKERS®**

SOLID CONSTRUCTION MEETS
RUGGED GOOD LOOKS

**DRESSING
COMPARTMENTS**

BENCHES



**SCRANTON
PRODUCTS®**
DESIGNED TO BE WORRY-FREE

www.scrantonproducts.com

why **PERFORMANCE** PLASTICS



Eclipse Partitions – Color: Stainless, Texture: Rotary Brushed
Configuration: Floor Mounted Overhead Braced, Height: 55" Standard Panels & Doors
Urinal Screens – Color: Stainless

NO PAINTING

Scranton Products partitions are solid color throughout and will never require painting.

EASY GRAFFITI REMOVAL

Graffiti can be easily wiped clean with a common, non-abrasive cleaner.

CLEANER, HEALTHIER RESTROOMS

Impermeable to moisture, solid plastic's non-porous surface does not support the growth of mold and mildew and will never rust.

Commercial bathroom partitions are placed in harsh, high traffic environments that tend to be damp, making the materials susceptible to mold, mildew and rust. It is also common to encounter graffiti and vandalism in these public spaces.

It is important to invest in a worry-free product that will save you time and money.

Solid plastic partitions are built to last, down to every detail. Graffiti can be easily wiped clean with a common non-abrasive cleaner, and since Scranton Products performance plastic is formulated with a solid color throughout, scratches are difficult to see. Compared to other traditional material types, performance plastic has a greater resistance to impacts and dents providing you with a low maintenance restroom that will look great for years.

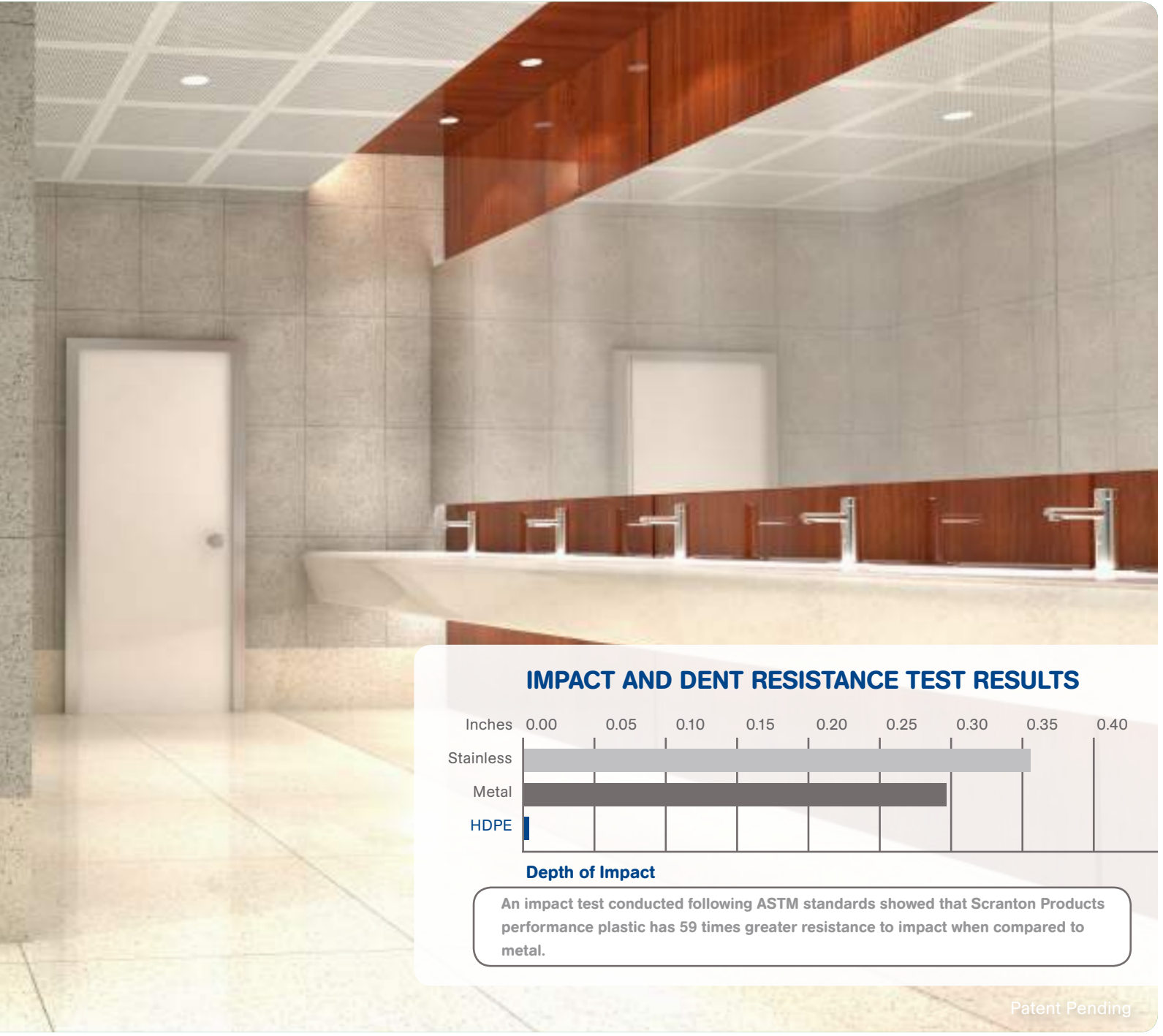

IMPACT AND DENT RESISTANCE TEST RESULTS

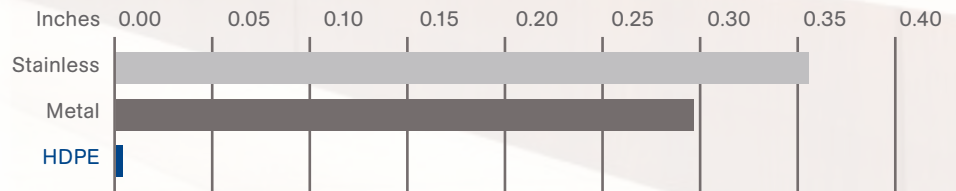

Depth of Impact

An impact test conducted following ASTM standards showed that Scranton Products performance plastic has 59 times greater resistance to impact when compared to metal.

Patent Pending

NATURALLY GERM RESISTANT

Scranton Products performance plastic partitions are naturally resistant to common bacteria including MRSA. Testing has shown that after 24 hours, 98.4% of MRSA died off the surface of solid plastic without the use of cleaning solutions or antimicrobial additives. What's more, Scranton Products partitions are fully power washable and steam cleanable.

privacy by **DESIGN**

Eclipse Partitions – Color: White, Texture: Orange Peel
Configuration: Floor Mounted Overhead Braced, Height: 62" Standard Panels & Doors

Eclipse Partitions are the future of restroom partitions that offer both **innovative design aesthetics** and **durable performance**.

The **clean lines** of this system provide a **contemporary** look to any bathroom décor. The **high privacy design** delivers superior **privacy** above traditional partitions.



ECLIPSE PARTITIONS™

FEATURES

- High privacy design
- Innovative hinge & post design structure
- Sleek profile with hidden brackets
- Contemporary anti-grip head rail
- Durable solid performance plastic material

Patent Pending

next GENERATION OF PARTITIONS

Eclipse Partitions – Color: Gravel, Texture: Orange Peel
Configuration: Floor Mounted Overhead Brace, Height: 62” Standard Panels & Doors



INNOVATIVE HINGE

The new concealed pivot hinge allows for smooth closure and adjustability.

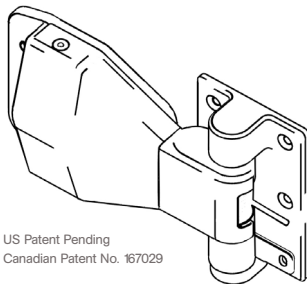

US Patent Pending
Canadian Patent No. 167029

ANGLED DOOR EDGES

Offers reduced sight lines for the utmost privacy.

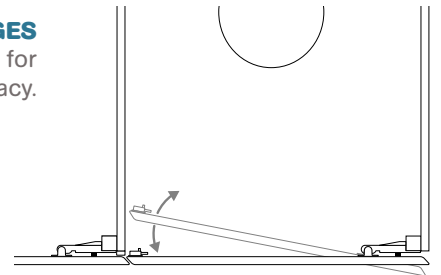



**ECLIPSE
PARTITIONS™**



ECLIPSE PARTITIONS

Combining **innovative aesthetics** with **durable** performance, Eclipse Partitions' **high privacy design** offers the ultimate in privacy. The **contemporary** look and extensive color and texture collections are sure to enhance your facility décor.

Patent Pending

LESS VISIBLE HARDWARE

No unsightly hardware visible on the outside of the stalls.



HEIGHT OPTIONS

55" standard, *62" high, and *72" extra high doors and panels.

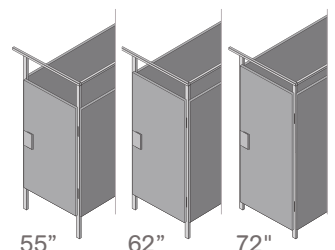

55"

62"

72"

*Modular panel may be required if stall depth is greater than 55".

COLOR, TEXTURE & DESIGN OPTIONS



CLASSIC COLOR COLLECTION

Swatches shown in Orange Peel.



MOSAIC COLOR COLLECTION

Swatches shown in Orange Peel.



DESIGNER COLOR COLLECTION

Swatches shown in Orange Peel.

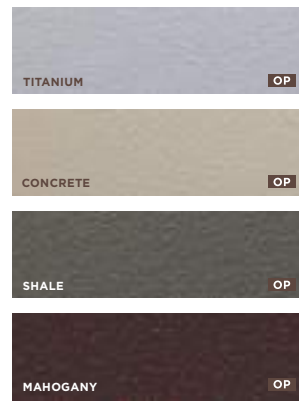

METALLIC COLOR COLLECTION

Swatches shown in Hammered.



TEXTURE

Swatches shown in Grey.

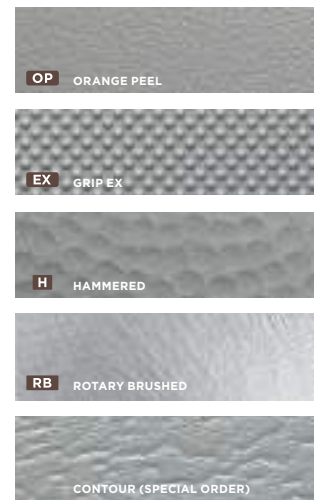

CUSTOM COLORS AVAILABLE UPON REQUEST.

Color matching is limited by printing process. Actual samples are available and recommended prior to color selections.

*Special orders require extended lead times. Minimum order requirements may apply.



DESIGN OPTIONS

BRACKETS

Aluminum
T Bracket
(Between Stalls)

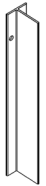

Aluminum
L Bracket
(End Of Run)



HINGES

Inswing
(Pivot Hinge)

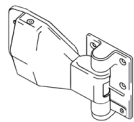

US Patent Pending
Canadian Patent No. 167029

Outswing

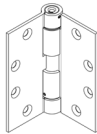

STANCHION

Stanchion Cap



Stanchion



Corner Cap



Stanchion Support

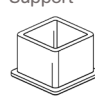

HEAD RAIL

Aluminum

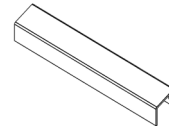

LATCH

Aluminum

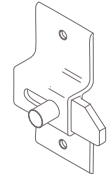

Occupancy
Indicator



HEIGHT OPTIONS



55" Standard



62" High*



72" Extra High*

*Modular panel may be required if stall depth is greater than 55".

CONFIGURATION OPTIONS

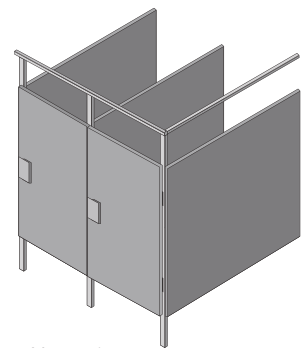

Floor Mounted
Overhead Braced

FIRE RATING

Whether your fire rating needs are NFPA 286, Class A, or Class B, we have the material to match.

style that **LASTS** AND LASTS

Hiny Hiders Partitions – Color: Grey, Texture: Orange Peel, Hardware: Continuous Aluminum Hinge & Strike
Configuration: Floor Mounted Overhead Braced, Height 72” Extra High Panels & Doors

With **tough** construction and **rugged** good looks, Hiny Hiders partitions offer durability that will **save** customers **time**, **hassle**, and **maintenance** costs. Hiny Hiders partitions offer **superior value** that simply **can't be beat** by the competition.



FEATURES

- Durable solid performance plastic material
- Solid classic construction
- Multiple hardware options
- Numerous design configurations
- High privacy options

the **CLASSIC** CONSTRUCTION

Hiny Hiders Partitions – Color: Black, Texture: Grip EX, Hardware: 8” Wrap Around Hinge
Configuration: Floor Mounted Overhead Braced, Height: 55” Standard Panels & Doors

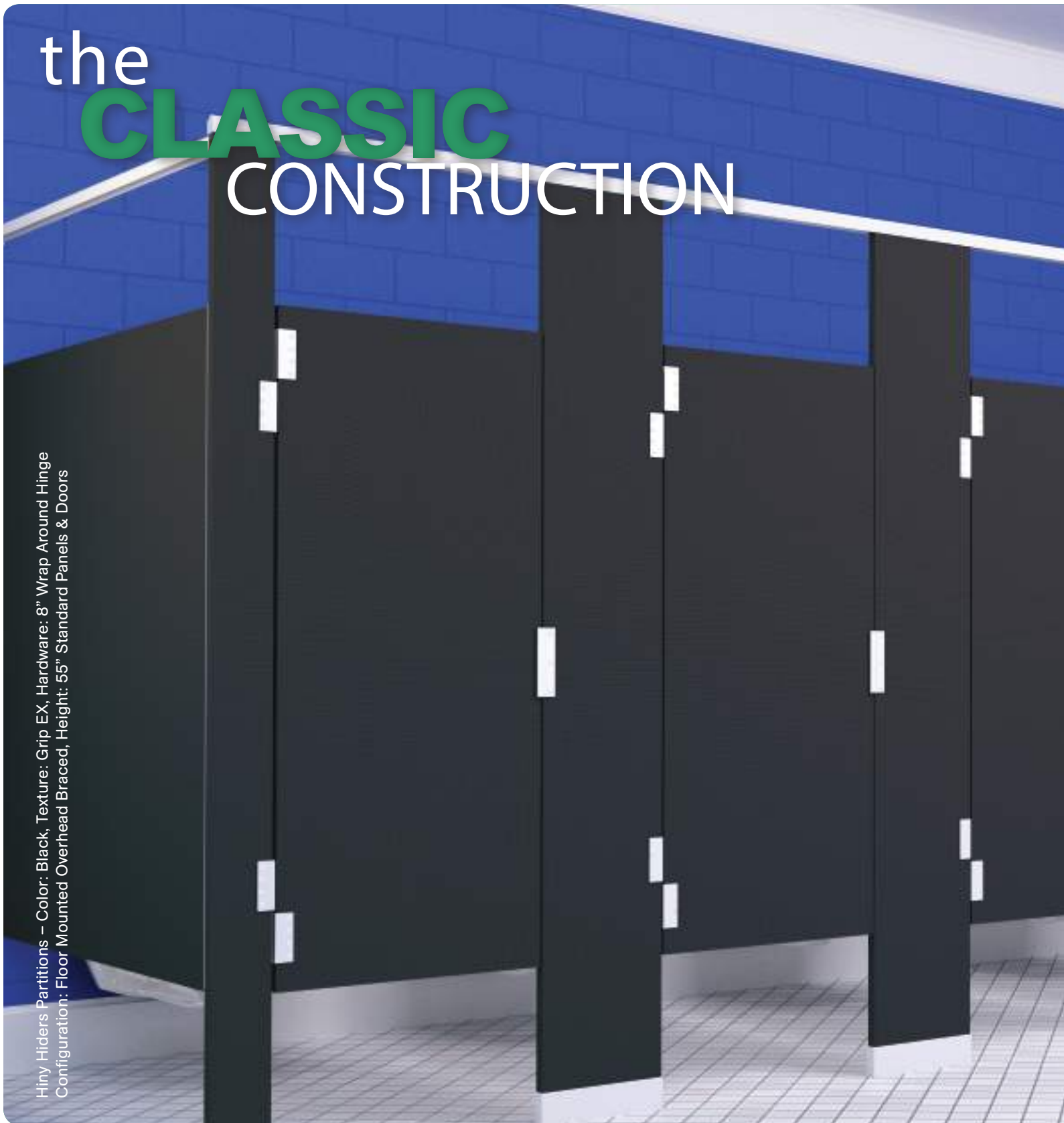

FLOOR MOUNTED OVERHEAD BRACED

This classic style provides the most economical solution for high traffic areas where durability is a top priority. Easy installation in new construction or existing buildings makes this a versatile style option.



**8" WRAP
AROUND HINGE**

This hinge provides the most durable and economical solution for any application.



GRIP EX TEXTURE

This texture provides additional protection in high traffic areas where graffiti is a concern.

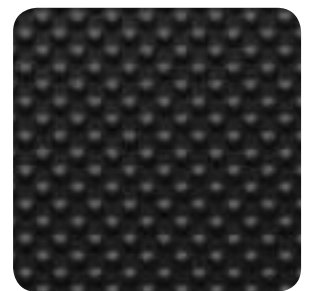

fast
EASY
MAINTENANCE

Hiny Hiders Partitions - Color: Bronze, Texture: Hammered, Hardware: Regal Hinge
Configuration: Ceiling Hung, Height: 55" Standard Panels & Doors



CEILING HUNG

This style offers an area free from obstruction to allow for fast and easy maintenance. The system requires structural supports in the ceiling for maximum rigidity.

120" Maximum Ceiling Height.



REGAL HINGE

This hinge provides a modern, bold design element and is perfect for adding a uniquely handsome and upscale finish to your bathroom stall.



HAMMERED TEXTURE

This texture creates a bold dimension to any color and stands out when paired with our metallic color collection.





adds
SUPERIOR
STRENGTH

Hiny Hiders Partitions – Color: Mahogany, Texture: Orange Peel, Hardware: Stealth Integral Hinge
Configuration: Floor To Ceiling, Height: 55" Standard Panels & Doors

FLOOR TO CEILING

This style provides an extra measure of stability in restrooms.
Maximum rigidity is achieved when structural supports are
present in the ceiling.

120" Maximum Ceiling Height.



STEALTH INTEGRAL HINGE

This hinge is a perfect hardware match for a space seeking a minimal design aesthetic.



ORANGE PEEL TEXTURE

This texture pairs great with any color choice and will compliment any environment.



COLOR, TEXTURE & DESIGN OPTIONS

CLASSIC COLOR COLLECTION

Swatches shown in Orange Peel.



MOSAIC COLOR COLLECTION

Swatches shown in Orange Peel.



DESIGNER COLOR COLLECTION

Swatches shown in Orange Peel.

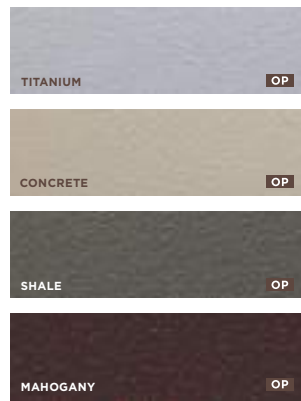

METALLIC COLOR COLLECTION

Swatches shown in Hammered.



TEXTURE

Swatches shown in Grey.

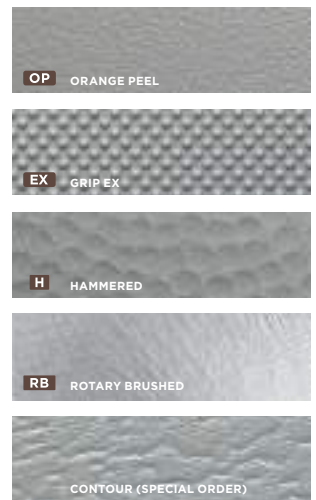

CUSTOM COLORS AVAILABLE UPON REQUEST.

Color matching is limited by printing process. Actual samples are available and recommended prior to color selections.

*Special orders require extended lead times. Minimum order requirements may apply.

DESIGN OPTIONS

STRIKES

6", 54", 65", 71" Aluminum

3" Stainless Steel Emergency Access

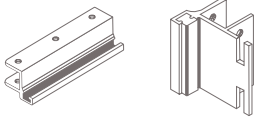

HINGES

8" Wrap Around

54", 65", 71" Continuous Aluminum

Regal Hinge

Vault Hinge

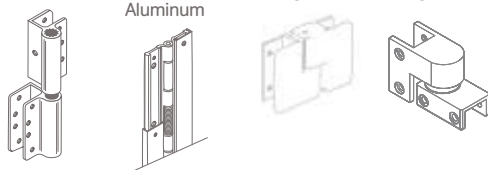

HEAD RAIL

Aluminum

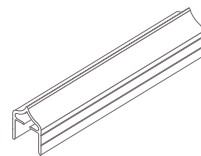

SLIDER



STIRRUP BRACKETS

Aluminum or Stainless Steel

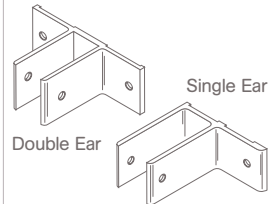

CONTINUOUS BRACKETS

54" Plastic, Stainless Steel or Aluminum
68" Aluminum Only

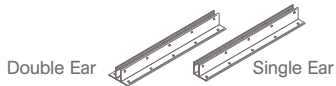

54", 71" Continuous Stainless Steel Helix

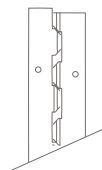

54" Continuous Stainless Steel Spring Loaded

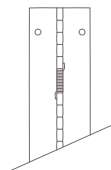

Stealth Integral Hinge



LATCHES

Aluminum or Stainless Steel



Occupancy Indicator



SHOES

Plastic ††

Stainless Steel

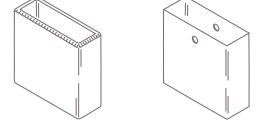

HEIGHT OPTIONS



55" Standard

66" High*

72" Extra High*

*Modular panel may be required if stall depth is greater than 55".

CONFIGURATION OPTIONS

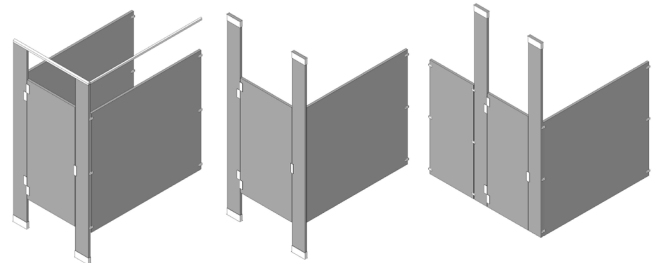

Floor Mounted Overhead Braced

Floor to Ceiling

Ceiling Hung

FIRE RATING

Whether your fire rating needs are NFPA 286, Class A, or Class B, we have the material to match.

†† Limited colors available.

additional **PRODUCT** OFFERINGS



URINAL SCREENS

Our urinal screens are designed to withstand use and abuse in public restrooms. Scranton Products solid performance plastic materials clean easily, making them the ideal option. Our privacy and urinal screens are available in four easy to maintain mounting configurations.



Floor Mounted
Overhead Braced*
* Hiny Hiders † Eclipse

Floor to
Ceiling*

Floor
Supported*

Wall
Mounted*†

SHOWER DIVIDERS

Scranton Products manufactures shower cubicles that are designed to perform in public shower areas. Solid plastic has no absorption of water and resists mold, mildew and odors. It is easy to clean and resists soap stains, making it the ideal material for your shower application.

Our shower cubicles feature an integrated head rail designed to accommodate optional curtain hooks and curtains, eliminating the need for additional curtain rods.



VANITIES

Scranton Products solid plastic vanity tops combine durability with long-lasting good looks. Offered in a wide variety of colors, our vanities provide an opportunity for you to match your partitions and compliment your overall design.

Our vanity tops have no absorption of water and resist mold, mildew and odors. They are easy to clean and resist soap stains, making them the ideal addition to your bathroom and will provide many years of worry-free performance.



DRESSING COMPARTMENTS

Our dressing compartments come in a wide variety of colors and textures providing many design options to compliment your décor. Scranton Products performance plastic resists dents, scratches, corrosion and graffiti which means customers save time, hassle and maintenance costs.

Our dressing compartments feature an integrated head rail designed to accommodate optional curtain hooks and curtains eliminating the need for additional curtain rods.

making a
HEALTHIER
ENVIRONMENT





MADE FROM RECYCLED MATERIALS

100% RECYCLABLE

CONTAINS 25%-100% PRE & POST-CONSUMER CONTENT

NO PAINTING MEANS NO VOC EMISSIONS

RESISTS MOLD, MILDEW, FUNGUS AND BACTERIA

FACTORY RESPONSIBLE RECYCLING

AVAILABLE 100% POST-CONSUMER MATERIAL

CONTRIBUTES POINTS TO LEED CERTIFICATION



EASY ON THE ENVIRONMENT

When you choose Scranton Products performance plastic materials, you are supporting a healthier environment. Our partitions reduce industrial waste by using a blend of virgin and pre and post-consumer recycled content to produce a high quality product that is 100% recyclable.

Our GREENGUARD Gold Certified partitions meet strict criteria for products intended for use in environments where children spend significant periods of time. Because our partitions never need painting, they do not contribute to VOC emissions, which improves both indoor and outdoor air quality. In addition, they can be power washed or steam cleaned, eliminating the need for harmful chemical cleaners.

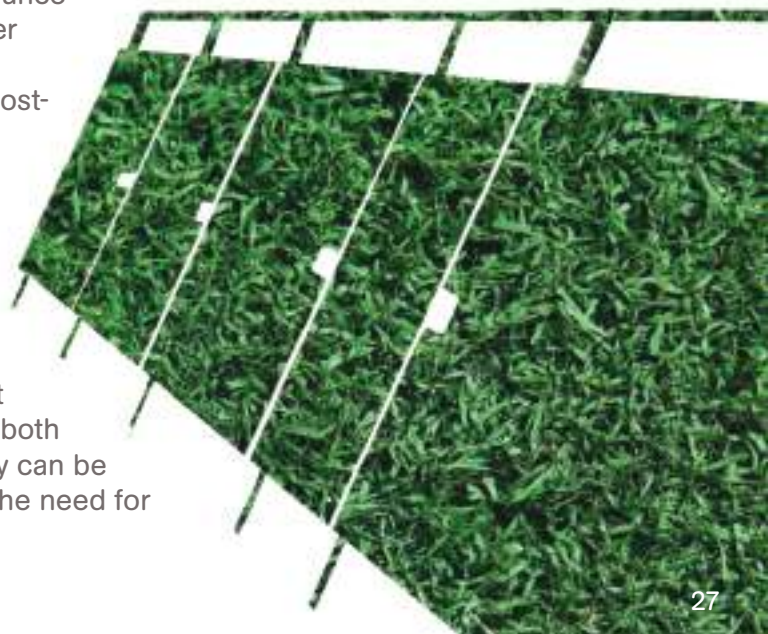

WE DON'T JUST TALK TOUGH.

WE BACK IT UP.

Proudly made in the USA,
Scranton Products' brands provide
industry leading protection.
We are so confident that our plastic
partitions will stand the test of time
that they are backed with a full
25-year warranty covering
breakage, corrosion and
delamination under normal
conditions.

BATHROOM PARTITIONS
LOCKERS
LOCKER ROOM BENCHES
SHOWER CUBICLES
DRESSING COMPARTMENTS
VANITIES



**SCRANTON
PRODUCTS**
DESIGNED TO BE WORRY-FREE

801 E. Corey Street
Scranton, PA 18505
800.445.5148
Fax: 855.376.6161
info@scrantonproducts.com
www.scrantonproducts.com
Patent Pending