

WOOD  
WORK  
SHELVES

# Planning Guide

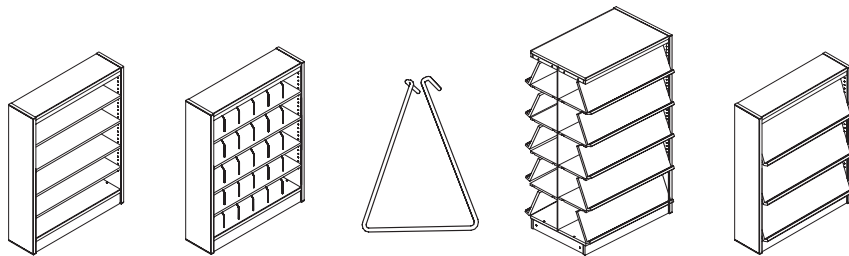

J A S P E R  
L I B R A R Y  
F U R N I T U R E



## Sherwood Shelving Planning Guide

### TABLE OF CONTENTS

Warranty .....	1
Mission Statement .....	2
Product Specifications.....	3
Ordering Information .....	4
Single-Faced Bookcase Shelving.....	5-6
Double-Faced Bookcase Shelving .....	7-8
Single-Faced Magazine Shelving.....	9-10
Double-Faced Magazine Shelving.....	11-12
Single-Faced Picture Book Shelving.....	13
Double-Faced Picture Book Shelving.....	14-15
Accessories .....	16-19
Index.....	20

#### SEATING

*Please reference our complete 234-page Community catalog for wood seating and lounge options.*

#### WARRANTY

*Community warrants to the original purchaser that each piece of furniture will be free from defects in workmanship given normal use for five years. Casters are warranted to be free from defects in materials and workmanship for a period of five years. Community will, at its option, repair or replace any defective merchandise within the terms of the warranty. This warranty does not apply to damage resulting from accident, alteration, or misuse.*

# Environmental Mission Statement

COMMUNITY has been an environmentally conscious organization for more than 75 years. Founded in 1929 in a Southern Indiana area settled by skilled German woodcrafters, Community began as a manufacturer of durable, well-crafted chairs. Through the years, as we have grown and expanded our product lines to include office furniture casegoods, tables, and lounge seating products, this heritage and respect for the environment continues. Building a product that will last and not require disposal in a landfill is our focus. Community is committed to “reduce, reuse and recycle” and to the conservation of our environment and its natural resources, as well as the encouragement of our suppliers and customers to do the same. A goal of a “Green Partnership” (supplier, manufacturer and customer) is essential for the long-term protection, preservation and sustainability of our environment for future generations. Our Mission is to continually maximize the use of sustainable raw materials and to search for new materials and processes that will not negatively impact our environment.

## LOCATION

Our Community manufacturing facilities in Southern Indiana and North Carolina are often located within 500 miles of your project location, allowing you possible LEED credits toward Green Building Certification. With our diverse manufacturing capabilities, “one-stop shopping” is attainable, allowing you to conserve our fossil fuels and reduce greenhouse gases.

## PACKAGING

Community places an emphasis on the minimal use of disposable packaging, while still providing adequate protection of the finished product. Our corrugated packaging is 100% recyclable or reusable. The packaging we receive from our suppliers is also reused or recycled. We recycle more than one million pounds of cardboard annually.

## COMPLIANCE

Community employees are trained in compliance with applicable Occupational Safety and Health Administration (OSHA) regulations to exceed all applicable Department of Environmental Management (DEM) and Environmental Protection Agency (EPA) regulations for air emissions, storm water and hazardous waste disposal. Our safety philosophy is a 360-degree circle of safety program which includes home, work and travel. Our manufacturing facilities use the DuPont Safety Training Observation Program (STOP) supervision program for workplace environmental accident prevention and awareness.

## MANUFACTURING FACILITIES

All of our Community manufacturing facilities are geared toward eco-efficiency and are encouraged to continually improve and conserve. Wood not used in the direct manufacturing process is recycled for use in concealed reinforcement cleats and corner blocks. Additional scrap materials are burned in scrubber-equipped boilers to generate steam that is used in the manufacturing process to operate our dry kilns or to heat our manufacturing facility during the winter. This process reduces greenhouse gases, the use of fossil fuels, and the burden of waste placed in landfills. In addition to other energy savings techniques, our manufacturing facilities use high-efficiency lighting, make use of power factor capacitors, and encourage the reduction of energy consumption and water usage. Condensation pumps are used to aid in water savings as well as extending boiler life.

## MANUFACTURING PROCESSES

Community manufacturing facilities utilize finish and assembly processes that best support the furniture requirements and applications. We continually test the latest equipment and materials available to reduce emissions while maintaining the best quality product possible. Finish lines utilize highly efficient spray guns and spray techniques to reduce waste material. Excess finish material, solvents and waste are recycled. Flat line ultraviolet-cured finishing systems enable the excess finish material to be recaptured, recycled, and reused with no post-cure byproducts. Many assembly processes use water-based glues that contain no hazardous ingredients.

## TEXTILES

Many of our fabric options utilize 100% recycled content. A grouping of leather alternatives contain no toxic materials, plasticizers, heavy metals or formaldehyde and have a 100% biodegradable back cloth. Available panel fabric uses a biological nutrient for the soil if discarded. Components – cushion foam, batting and poly-cord – used in upholstered products are recyclable and contain various percentages of recycled content. Excess fabric and leathers not utilized in the upholstery process are supplied to recyclers and local charities for additional use.

## WOOD

Wood is good! It is the most diverse, process friendly, and widely utilized natural resource in mankind’s history. No other natural resource can match the environmental advantages of wood. It is renewable, recyclable, and biodegradable. Utilizing the sun’s energy, trees grow and remove carbon dioxide from the air while giving off oxygen to benefit the entire planet. Harvesting mature trees in a sustainable forest allows the photosynthetic cycle to continue at full optimization. We are proud to use wood as our primary “Green” renewable material resource.

Surprisingly, much of the public has the impression that processing wood involves wasting natural resources and destroying the environment, when just the opposite is true! According to the U.S. Forest Service, each year the U.S. grows about 50 percent more trees than are cut for furniture manufacturing. In fact, since 1952 the amount of commercial hardwood forest stock has increased by 70 percent. The hardwood industry currently utilizes approximately 13 billion board feet of standing timber per year. Current statistics from the Forest Service indicate that there are more than 715 billion board feet of commercial-size timber available for harvest. The United Nation’s 2007 *State of the World’s Forests* report shows that the United States forests are getting larger each year. The United States practices sustainable forestry both in the softwood and hardwood industries.

## MATERIAL OPTIONS

Alternative materials are available for consideration from Community. Solid wood and engineered wood options like Lyptus®, Plyboo®, reclaimed woods, agricultural and post-consumer waste fiber products, soy-based resin bio-composites, Forest Stewardship Council (FSC) certified wood – the list continues to grow – all allow possible LEED credits toward Green Building Certification. These options can be considered for specific applications based on their performance. We support sustainable forestry by purchasing wood products grown in sustainable forest programs.

*Community’s goal is to provide value for our customers and to expand and improve our “Green Partnerships” through process, product and life cycle management.*

# Sherwood Starter/Adder Wood Shelving Specifications

## GENERAL CONSTRUCTION

Sherwood shelving is a modular starter/adder design which allows for easy re-configuration.

## END AND INTERMEDIATE PANELS

The end and intermediate panels shall be constructed of 1"-thick plywood core for excellent dimensional stability. The face veneers shall be Grade "A" quality. All end panels shall be banded on all four sides with an eased  $\frac{1}{8}$ " external band. The inside faces of the end panels shall have two rows of holes bored to accept the shelf pins. The holes shall be 32 mm on center. The end panels shall be grooved to accept the  $\frac{1}{4}$ "-thick back panel.

## CORNICE TOP

The cornice top shall be constructed of 1"-thick plywood core with Grade "A" face veneers. The front edge shall receive a  $\frac{3}{4}$ "-thick x 2"-high valance. The valance shall be recessed  $\frac{1}{8}$ " from the front edge and attached to the top by means of three (3) #10 x 2  $\frac{1}{2}$ " flat head wood screws. The cornice top shall be attached to each of the vertical panels by means of black wood screws passing through an 8  $\frac{1}{2}$ " long Z-shaped bracket, which will pull the top tight to the vertical panels.

## SHELVING BASE

The toe kicks for both single-faced and double-faced shall be 1"-thick by 4"-high and constructed of veneer core hardwood plywood with a minimum of nine plies. The toe kicks shall attach to the end and intermediate panels by means of wood screws passing through a 3"-high L-shaped bracket. The rear base rail on single-faced shelving and the center rail on double-faced shelving shall have the top edge grooved to receive the back panel.

## STANDARD ADJUSTABLE SHELF

The adjustable shelves shall be 1"-thick plywood core with an eased external band on the front edge. The underside of the shelf shall be routed to accept the shelf pins.

## STANDARD MAGAZINE SHELF

The magazine shelves shall be constructed of 1"-thick minimum nine-ply oak or maple hardwood veneer core. The shelf shall have a solid hardwood retaining edge to hold the magazines in their inclined, displayed position. The shelf rests on four adjustable shelf pins pivoting upward on the rear pins to access the flat "adjustable" storage shelf beneath.

## OPTIONAL METAL SHELF

The optional adjustable metal shelf shall be 18-gauge steel. The shelf shall be  $\frac{3}{4}$ "-high with the front and rear edges being square formed. The ends of the shelves shall be notched to accept the shelf pins. The shelves shall be electrostatically painted.

## STANDARD BACK PANEL

The standard back panels shall be  $\frac{1}{4}$ "-thick with a vertical grade laminate face.

## OPTIONAL VENEER BACK PANEL

The optional veneer back panel shall be  $\frac{1}{4}$ "-thick plywood with select rotary cut face veneer on exposed face(s).

## OPTIONAL CONTINUOUS TOPS

The optional continuous tops are available for all shelving units. They shall be  $1\frac{3}{16}$ "-thick and come standard with a  $\frac{1}{2}$ " square internal edge band. The designer edges are available as an option. They are  $1\frac{3}{16}$ "-thick with a  $\frac{3}{4}$ "-shaped internal edge band. The catalog numbers must be called out to indicate this selection.

## OPTIONAL MOBILE BASE

The optional mobile base is available on the double-faced shelving units. The swivel casters shall be bolted to the underside of the shelving unit by means of four metal corner brackets. These brackets shall provide extra bracing by having four bends and attaching to the end panels and shelving base by means of wood screws.

## CORNER FILLERS

The corner fillers shall be constructed of plywood core with a Grade "A" veneer face. Solid hardwood cleats shall be provided for attachment to the shelving run and the wall. The depth and width is to be specified at time of purchase order.

## FACE FILLERS

The face fillers shall be constructed of plywood core with a Grade "A" veneer face. Solid hardwood cleats shall be provided for attachment to the shelving run and the wall. The height and width is to be specified at time of purchase order.

# Sherwood Ordering Information

1. MODEL NUMBER

2. STANDARD WOOD SPECIES: Oak or Maple

3. WOOD FINISH:

**Oak**

- NOO Natural Oak
- GOO Golden Oak
- MOO Medium Oak
- LCO Light Cherry
- MCO Medium Cherry
- MWO Medium Walnut
- MMO Medium Mahogany
- DMO Dark Mahogany

**Maple**

- NMM Natural Maple
- AMM Amber Maple
- LCM Light Cherry
- MCM Medium Cherry
- MWM Medium Walnut
- MMM Medium Mahogany
- DMM Dark Mahogany

4. EDGE DETAILS for designer edge, continuous tops only:

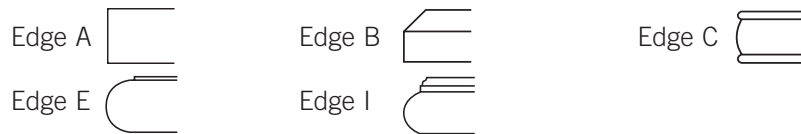

\* Standard Sherwood continuous top edge: 

5. ALL BACK PANELS TO BE ORDERED SEPARATELY.

If melamine, specify back panel color: NOO, MOO, NMM, Black, Almond.

Optional veneer back panel available in any wood finish.

6. TOPS: Wood veneer standard; plastic laminate available on units 48" and lower.

Add (-P) to model number (ex. SD3010BC-S-P).

Select from the following standard laminate choices: Wilsonart, Formica or Pionite.

When ordering please specify manufacturer, color and model number.

7. METAL SHELVES: Add the suffix (-M) to the model number (ex. SD3010BC-S-M).

Call Customer Service for color options.

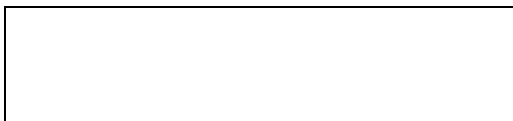



# Sherwood Single-Faced Bookcase Shelving

for specifications, please see page 3 • for ordering information, please see page 4

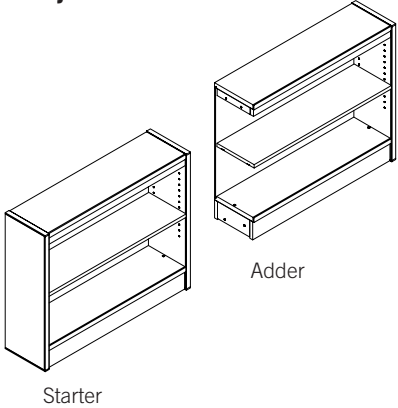
	Model	Size	Description	Weight	List Price	
					Oak	Maple
<b>1 Adjustable Shelf</b>						
	SD3010BC-S	30" H x 10" D x 36" W	S/F Starter	53	\$ 460	\$ 515
	SD3010BC-A	30" H x 10" D x 36" W	S/F Adder	45	393	440
	SD3012BC-S	30" H x 12" D x 36" W	S/F Starter	60	467	523
	SD3012BC-A	30" H x 12" D x 36" W	S/F Adder	52	399	447
	SD3610BC-S	36" H x 10" D x 36" W	S/F Starter	53	\$ 468	\$ 524
	SD3610BC-A	36" H x 10" D x 36" W	S/F Adder	45	407	456
	SD3612BC-S	36" H x 12" D x 36" W	S/F Starter	60	472	529
	SD3612BC-A	36" H x 12" D x 36" W	S/F Adder	52	411	460

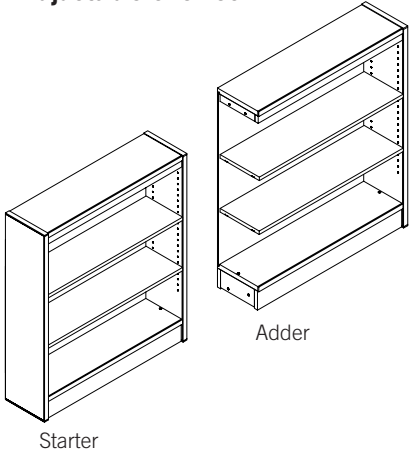
<b>2 Adjustable Shelves</b>						
	SD4210BC-S	42" H x 10" D x 36" W	S/F Starter	60	\$ 591	\$ 662
	SD4210BC-A	42" H x 10" D x 36" W	S/F Adder	52	470	526
	SD4212BC-S	42" H x 12" D x 36" W	S/F Starter	67	598	670
	SD4212BC-A	42" H x 12" D x 36" W	S/F Adder	59	477	534
	SD4810BC-S	48" H x 10" D x 36" W	S/F Starter	65	\$ 603	\$ 675
	SD4810BC-A	48" H x 10" D x 36" W	S/F Adder	57	480	538
	SD4812BC-S	48" H x 12" D x 36" W	S/F Starter	72	610	683
	SD4812BC-A	48" H x 12" D x 36" W	S/F Adder	64	487	545

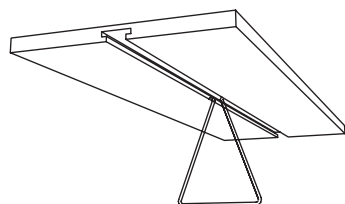

HANGING TRIANGLE BOOK SUPPORT  
WITH GROOVED SHELF

Add **(-TBS)** to model number.

*Individual triangle book support is listed on page 17.*

\$ 24  
*(per shelf opening)*

To order adjustable metal shelves in lieu of adjustable wood shelves, please add the suffix (-M) at the end of the wood model number. All shelving sizes are nominal. Actual dimension drawings are available upon request after order is placed.

# Sherwood Single-Faced Bookcase Shelving

for specifications, please see page 3 • for ordering information, please see page 4

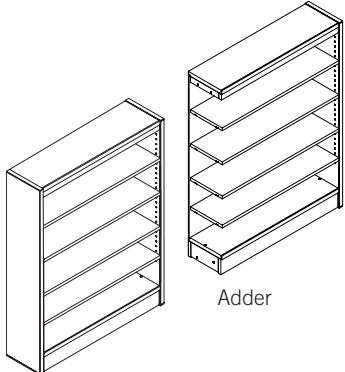
	Model	Size	Description	Weight	List Price		
					Oak	Maple	
<b>4 Adjustable Shelves</b>							
	SD6010BC-S	60" H x 10" D x 36" W	S/F Starter	82	\$ 721	\$ 808	
	SD6010BC-A	60" H x 10" D x 36" W	S/F Adder	74	583	653	
	SD6012BC-S	60" H x 12" D x 36" W	S/F Starter	96	732	820	
	SD6012BC-A	60" H x 12" D x 36" W	S/F Adder	88	594	665	
	SD7210BC-S	72" H x 10" D x 36" W	S/F Starter	92	\$ 787	\$ 881	
	SD7210BC-A	72" H x 10" D x 36" W	S/F Adder	84	649	727	
	SD7212BC-S	72" H x 12" D x 36" W	S/F Starter	106	800	896	
	SD7212BC-A	72" H x 12" D x 36" W	S/F Adder	98	662	741	

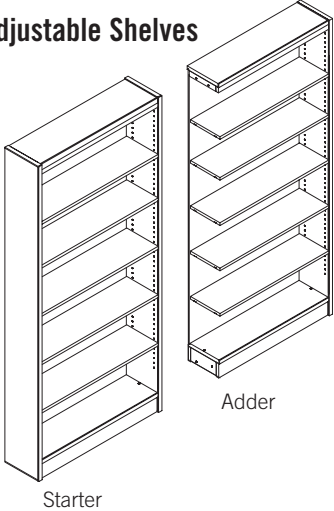
<b>5 Adjustable Shelves</b>							
	SD8210BC-S	82" H x 10" D x 36" W	S/F Starter	102	\$ 835	\$ 935	
	SD8210BC-A	82" H x 10" D x 36" W	S/F Adder	94	668	748	
	SD8212BC-S	82" H x 12" D x 36" W	S/F Starter	116	888	995	
	SD8212BC-A	82" H x 12" D x 36" W	S/F Adder	108	714	800	

To order adjustable metal shelves in lieu of adjustable wood shelves, please add the suffix (-M) at the end of the wood model number.  
 All shelving sizes are nominal. Actual dimension drawings are available upon request after order is placed.



# Sherwood Double-Faced Bookcase Shelving

for specifications, please see page 3 • for ordering information, please see page 4

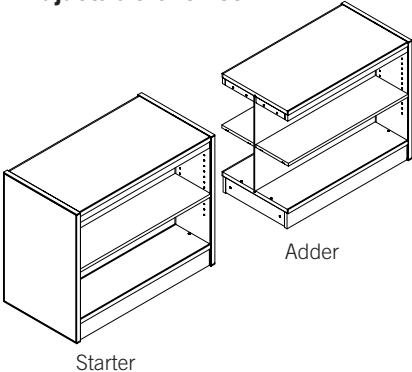
	Model	Size	Description	Weight	List Price	
					Oak	Maple
<b>2 Adjustable Shelves</b>						
 <p>Starter</p> <p>Adder</p>	SD3020BC-S	30" H x 20" D x 36" W	D/F Starter	99	\$ 842	\$ 943
	SD3020BC-A	30" H x 20" D x 36" W	D/F Adder	91	677	758
	SD3024BC-S	30" H x 24" D x 36" W	D/F Starter	106	895	1,002
	SD3024BC-A	30" H x 24" D x 36" W	D/F Adder	98	732	820
	SD3620BC-S	36" H x 20" D x 36" W	D/F Starter	105	\$ 889	\$ 996
	SD3620BC-A	36" H x 20" D x 36" W	D/F Adder	97	726	813
	SD3624BC-S	36" H x 24" D x 36" W	D/F Starter	112	942	1,055
	SD3624BC-A	36" H x 24" D x 36" W	D/F Adder	104	754	844

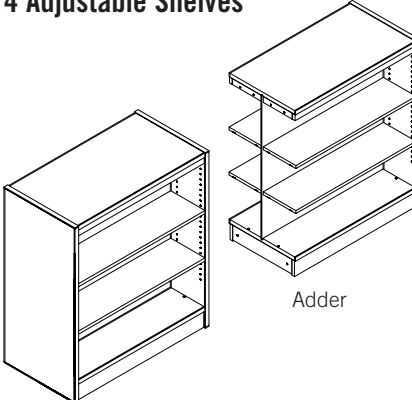
<b>4 Adjustable Shelves</b>						
 <p>Starter</p> <p>Adder</p>	SD4220BC-S	42" H x 20" D x 36" W	D/F Starter	106	\$ 932	\$ 1,044
	SD4220BC-A	42" H x 20" D x 36" W	D/F Adder	98	767	859
	SD4224BC-S	42" H x 24" D x 36" W	D/F Starter	127	983	1,101
	SD4224BC-A	42" H x 24" D x 36" W	D/F Adder	119	818	872
	SD4820BC-S	48" H x 20" D x 36" W	D/F Starter	115	\$ 972	\$ 1,089
	SD4820BC-A	48" H x 20" D x 36" W	D/F Adder	107	807	904
	SD4824BC-S	48" H x 24" D x 36" W	D/F Starter	118	1,023	1,146
	SD4824BC-A	48" H x 24" D x 36" W	D/F Adder	110	858	961

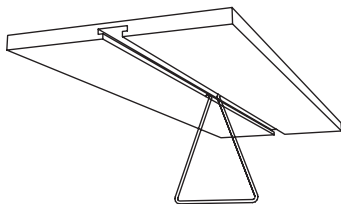

HANGING TRIANGLE BOOK SUPPORT  
WITH GROOVED SHELF

Add **(-TBS)** to model number.

*Individual triangle book support is listed on page 16.*

\$ 24  
(per shelf opening)

OPTIONAL MOBILE SHELVING BASE – 24" D x 36" W  
Add **(-MB)** to model number when ordering. Additional upcharge \$350 list.  
**Available ONLY for 30" to 48" high double-faced units.**  
**This piece MUST be ordered with the shelving units.**  
**Shelving units cannot be modified for future installation.**

To order adjustable metal shelves in lieu of adjustable wood shelves, please add the suffix **(-M)** at the end of the wood model number.  
All shelving sizes are nominal. Actual dimension drawings are available upon request after order is placed.



# Sherwood Double-Faced Bookcase Shelving

for specifications, please see page 3 • for ordering information, please see page 4

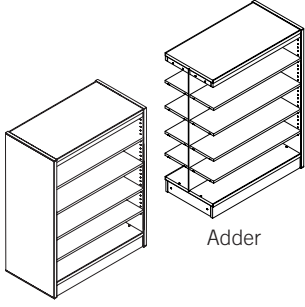
	Model	Size	Description	Weight	List Price		
					Oak	Maple	
<b>8 Adjustable Shelves</b>							
	SD6020BC-S	60" H x 20" D x 36" W	D/F Starter	148	\$ 1,347	\$ 1,509	
	SD6020BC-A	60" H x 20" D x 36" W	D/F Adder	140	1,189	1,332	
	SD6024BC-S	60" H x 24" D x 36" W	D/F Starter	169	1,261	1,412	
	SD6024BC-A	60" H x 24" D x 36" W	D/F Adder	161	1,103	1,235	
	SD7220BC-S	72" H x 20" D x 36" W	D/F Starter	158	\$ 1,424	\$ 1,595	
	SD7220BC-A	72" H x 20" D x 36" W	D/F Adder	150	1,266	1,418	
	SD7224BC-S	72" H x 24" D x 36" W	D/F Starter	164	1,338	1,499	
	SD7224BC-A	72" H x 24" D x 36" W	D/F Adder	156	1,180	1,322	

## 10 Adjustable Shelves

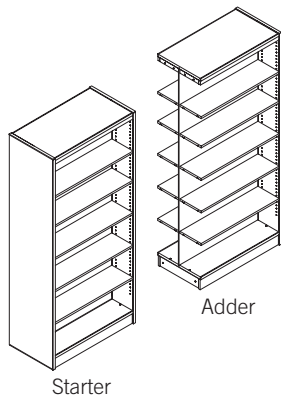

SD8220BC-S	82" H x 20" D x 36" W	D/F Starter	163	\$ 1,500	\$ 1,680
SD8220BC-A	82" H x 20" D x 36" W	D/F Adder	155	1,194	1,337
SD8224BC-S	82" H x 24" D x 36" W	D/F Starter	168	1,626	1,821
SD8224BC-A	82" H x 24" D x 36" W	D/F Adder	160	1,328	1,487

To order adjustable metal shelves in lieu of adjustable wood shelves, please add the suffix (-M) at the end of the wood model number. All shelving sizes are nominal. Actual dimension drawings are available upon request after order is placed.

# Sherwood Single-Faced Magazine Shelving

for specifications, please see page 3 • for ordering information, please see page 4

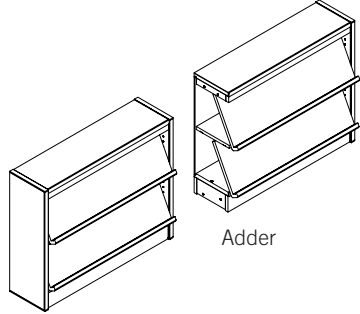
	Model	Size	Description	Weight	List Price	
					Oak	Maple
 <p>Starter</p> <p>Adder</p>	SD3612MG-S	36" H x 12" D x 36" W	S/F Starter with 2 magazine shelves and 1 adjustable shelf	60	\$ 614	\$ 688
	SD3612MG-A	36" H x 12" D x 36" W	S/F Adder with 2 magazine shelves and 1 adjustable shelf	55	553	619
	SD4212MG-S	42" H x 12" D x 36" W	S/F Starter with 2 magazine shelves and 1 adjustable shelf	80	\$ 740	\$ 829
	SD4212MG-A	42" H x 12" D x 36" W	S/F Adder with 2 magazine shelves and 1 adjustable shelf	75	619	693

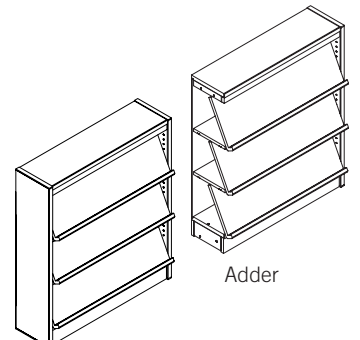
 <p>Starter</p> <p>Adder</p>	SD4812MG-S	48" H x 12" D x 36" W	S/F Starter with 3 magazine shelves and 2 adjustable shelves	85	\$ 823	\$ 922
	SD4812MG-A	48" H x 12" D x 36" W	S/F Adder with 3 magazine shelves and 2 adjustable shelves	80	700	784

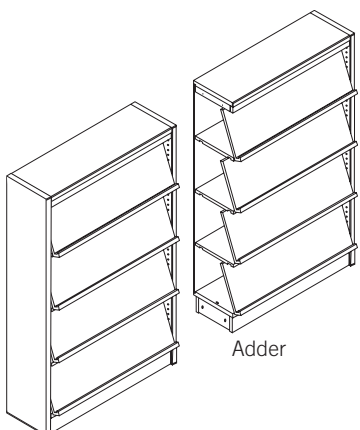
 <p>Starter</p> <p>Adder</p>	SD6012MG-S	60" H x 12" D x 36" W	S/F Starter with 4 magazine shelves and 3 adjustable shelves	105	\$ 1,016	\$ 1,138
	SD6012MG-A	60" H x 12" D x 36" W	S/F Adder with 4 magazine shelves and 3 adjustable shelves	100	878	983

To order adjustable metal shelves in lieu of adjustable wood shelves, please add the suffix (-M) at the end of the wood model number. All shelving sizes are nominal. Actual dimension drawings are available upon request after order is placed.

800.622.5661 | 812.482.3204 | fax 812.481.9675 | www.communityfurniture.com

# Sherwood Single-Faced Magazine Shelving

for specifications, please see page 3 • for ordering information, please see page 4

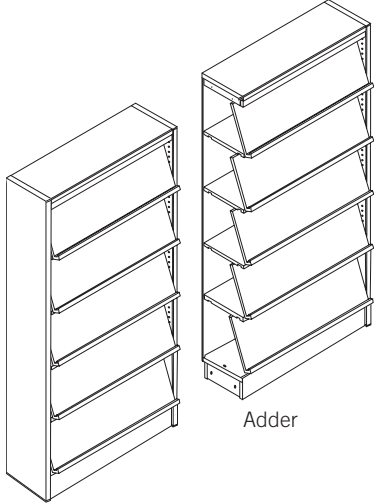
	Model	Size	Description	Weight	List Price	
					Oak	Maple
 <p>Starter</p> <p>Adder</p>	SD7212MG-S	72" H x 12" D x 36" W	S/F Starter with 5 magazine shelves and 4 adjustable shelves	125	\$ 1,261	\$ 1,412
	SD7212MG-A	72" H x 12" D x 36" W	S/F Adder with 5 magazine shelves and 4 adjustable shelves	120	1,123	1,258
	SD8212MG-S	82" H x 12" D x 36" W	S/F Starter with 5 magazine shelves and 4 adjustable shelves	142	\$ 1,364	\$ 1,528
	SD8212MG-A	82" H x 12" D x 36" W	S/F Adder with 5 magazine shelves and 4 adjustable shelves	137	1,226	1,373

To order adjustable metal shelves in lieu of adjustable wood shelves, please add the suffix (-M) at the end of the wood model number.  
 All shelving sizes are nominal. Actual dimension drawings are available upon request after order is placed.

# Sherwood Double-Faced Magazine Shelving

for specifications, please see page 3 • for ordering information, please see page 4

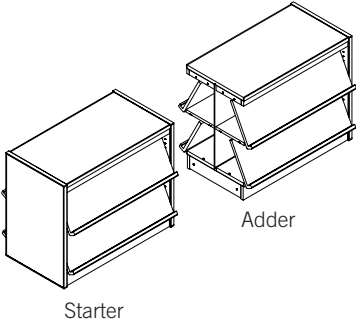
	Model	Size	Description	Weight	List Price	
					Oak	Maple
 <p>Starter</p> <p>Adder</p>	SD3624MG-S	36" H x 24" D x 36" W	D/F Starter with 4 magazine shelves and 2 adjustable shelves	120	\$ 1,200	\$ 1,344
	SD3624MG-A	36" H x 24" D x 36" W	D/F Adder with 4 magazine shelves and 2 adjustable shelves	115	1,109	1,242
	SD4224MG-S	42" H x 24" D x 36" W	D/F Starter with 4 magazine shelves and 2 adjustable shelves	149	\$ 1,267	\$ 1,419
	SD4224MG-A	42" H x 24" D x 36" W	D/F Adder with 4 magazine shelves and 2 adjustable shelves	144	1,102	1,234

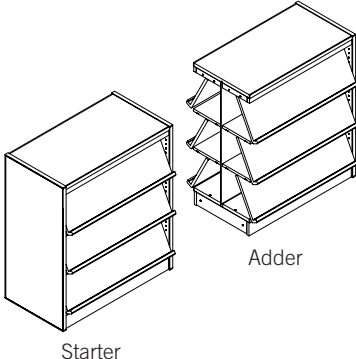
 <p>Starter</p> <p>Adder</p>	SD4824MG-S	48" H x 24" D x 36" W	D/F Starter with 6 magazine shelves and 4 adjustable shelves	155	\$ 1,449	\$ 1,623
	SD4824MG-A	48" H x 24" D x 36" W	D/F Adder with 6 magazine shelves and 4 adjustable shelves	150	1,284	1,438

## OPTIONAL MOBILE SHELVING BASE – 24" D x 36" W

Add **(-MB)** to model number when ordering. Additional upcharge \$350 list.

**Available ONLY for 30" to 48" high double-faced units.**

***This piece MUST be ordered with the shelving units.***

***Shelving units cannot be modified for future installation.***

To order adjustable metal shelves in lieu of adjustable wood shelves, please add the suffix **(-M)** at the end of the wood model number. All shelving sizes are nominal. Actual dimension drawings are available upon request after order is placed.

# Sherwood Double-Faced Magazine Shelving

for specifications, please see page 3 • for ordering information, please see page 4

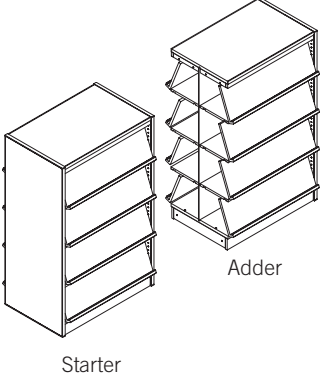
	Model	Size	Description	Weight	List Price	
					Oak	Maple
 <p>Starter</p>	SD6024MG-S	60" H x 24" D x 36" W	D/F Starter with 8 magazine shelves and 6 adjustable shelves	175	\$ 1,829	\$ 2,048
	SD6024MG-A	60" H x 24" D x 36" W	D/F Adder with 8 magazine shelves and 6 adjustable shelves	170	1,671	1,872

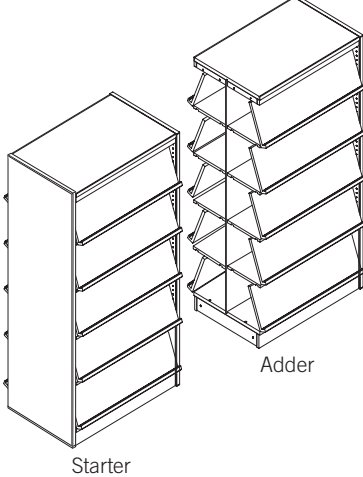
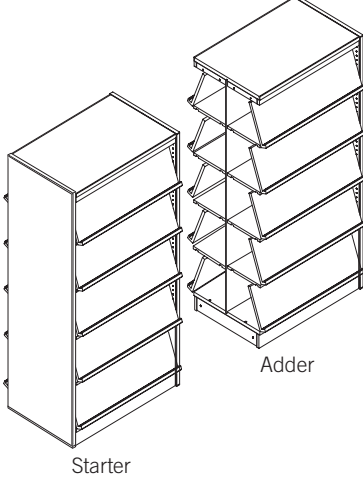
 <p>Starter</p>	SD7224MG-S	72" H x 24" D x 36" W	D/F Starter with 10 magazine shelves and 8 adjustable shelves	190	\$ 2,048	\$ 2,294
	SD7224MG-A	72" H x 24" D x 36" W	D/F Adder with 10 magazine shelves and 8 adjustable shelves	185	1,890	2,117
 <p>Starter</p>	SD8224MG-S	82" H x 24" D x 36" W	D/F Starter with 10 magazine shelves and 8 adjustable shelves	265	\$ 2,336	\$ 2,616
	SD8224MG-A	82" H x 24" D x 36" W	D/F Adder with 10 magazine shelves and 8 adjustable shelves	260	2,038	2,283

To order adjustable metal shelves in lieu of adjustable wood shelves, please add the suffix (-M) at the end of the wood model number. All shelving sizes are nominal. Actual dimension drawings are available upon request after order is placed.



# Sherwood Single-Faced Picture Book Shelving

for specifications, please see page 3 • for ordering information, please see page 4

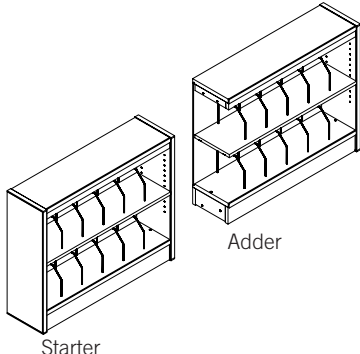
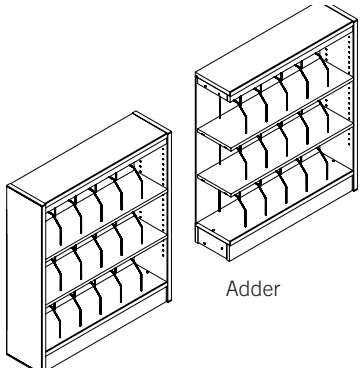
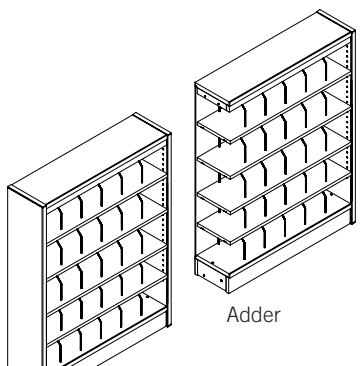
	Model	Size	Description	Weight	List Price	
					Oak	Maple
 <p>Starter</p> <p>Adder</p>	SD3012PB-S	30" H x 12" D x 36" W	S/F Starter with 1 adjustable shelf	50	\$ 527	\$ 590
	SD3012PB-A	30" H x 12" D x 36" W	S/F Adder with 1 adjustable shelf	40	459	514
	SD3612PB-S	36" H x 12" D x 36" W	S/F Starter with 1 adjustable shelf	65	\$ 532	\$ 596
	SD3612PB-A	36" H x 12" D x 36" W	S/F Adder with 1 adjustable shelf	55	471	528
 <p>Starter</p> <p>Adder</p>	SD4212PB-S	42" H x 12" D x 36" W	S/F Starter with 2 adjustable shelves	76	\$ 688	\$ 771
	SD4212PB-A	42" H x 12" D x 36" W	S/F Adder with 2 adjustable shelves	66	567	635
	SD4812PB-S	48" H x 12" D x 36" W	S/F Starter with 2 adjustable shelves	85	\$ 700	\$ 784
	SD4812PB-A	48" H x 12" D x 36" W	S/F Adder with 2 adjustable shelves	75	577	646
 <p>Starter</p> <p>Adder</p>	SD6012PB-S	60" H x 12" D x 36" W	S/F Starter with 4 adjustable shelves	97	\$ 882	\$ 988
	SD6012PB-A	60" H x 12" D x 36" W	S/F Adder with 4 adjustable shelves	87	744	833
	SD7212PB-S	72" H x 12" D x 36" W	S/F Starter with 4 adjustable shelves	115	\$ 950	\$ 1,064
	SD7212PB-A	72" H x 12" D x 36" W	S/F Adder with 4 adjustable shelves	105	812	909

If metal Picture Book shelves are required, contact Customer Service for upcharge.

All shelving sizes are nominal. Actual dimension drawings are available upon request after order is placed.

# Sherwood Double-Faced Picture Book Shelving

for specifications, please see page 3 • for ordering information, please see page 4

	Model	Size	Description	Weight	List Price	
					Oak	Maple

## 2 Adjustable Shelves

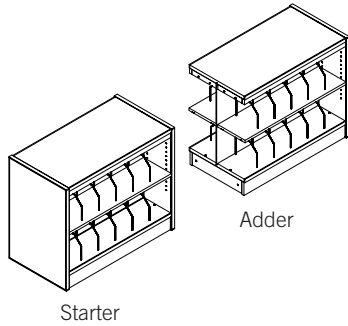

SD3024PB-S	30" H x 24" D x 36" W	D/F Starter	95	\$ 1,115	\$ 1,249
SD3024PB-A	30" H x 24" D x 36" W	D/F Adder	85	852	954
SD3624PB-S	36" H x 24" D x 36" W	D/F Starter	120	\$ 1,062	\$ 1,189
SD3624PB-A	36" H x 24" D x 36" W	D/F Adder	110	898	1,006

## 4 Adjustable Shelves

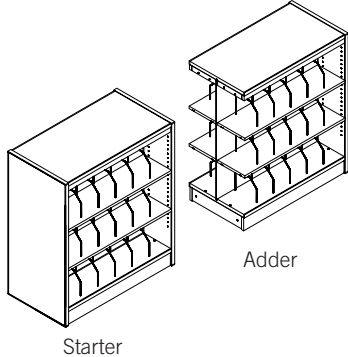

SD4224PB-S	42" H x 24" D x 36" W	D/F Starter	142	\$ 1,163	\$ 1,303
SD4224PB-A	42" H x 24" D x 36" W	D/F Adder	118	998	1,118
SD4824PB-S	48" H x 24" D x 36" W	D/F Starter	152	\$ 1,203	\$ 1,347
SD4824PB-A	48" H x 24" D x 36" W	D/F Adder	128	1,038	1,163

OPTIONAL MOBILE SHELVING BASE – 24" D x 36" W

Add **(-MB)** to model number when ordering. Additional upcharge \$350 list.

**Available ONLY for 30" to 48" high double-faced units.**

**This piece MUST be ordered with the shelving units.**

**Shelving units cannot be modified for future installation.**

If metal Picture Book shelves are required, contact Customer Service for upcharge.

All shelving sizes are nominal. Actual dimension drawings are available upon request after order is placed.

# Sherwood Double-Faced Picture Book Shelving

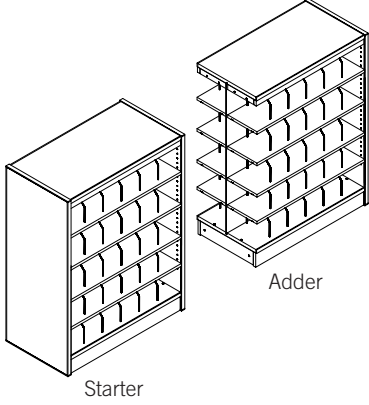

for specifications, please see page 3 • for ordering information, please see page 4

	Model	Size	Description	Weight	List Price	
					Oak	Maple
<b>8 Adjustable Shelves</b>						
 <p>Starter</p> <p>Adder</p>	SD6024PB-S	60" H x 24" D x 36" W	D/F Starter	180	\$ 1,561	\$ 1,748
	SD6024PB-A	60" H x 24" D x 36" W	D/F Adder	170	1,403	1,571
	SD7224PB-S	72" H x 24" D x 36" W	D/F Starter	228	\$ 1,638	\$ 1,835
	SD7224PB-A	72" H x 24" D x 36" W	D/F Adder	218	1,480	1,658

If metal Picture Book shelves are required, contact Customer Service for upcharge.  
 All shelving sizes are nominal. Actual dimension drawings are available upon request after order is placed.

# Sherwood Accessories

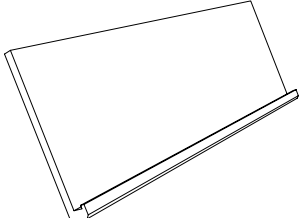
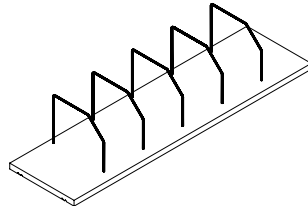
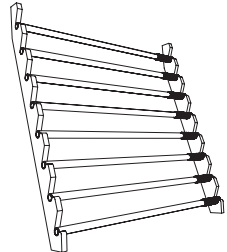
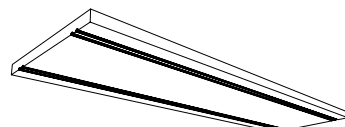
for specifications, please see page 3 • for ordering information, please see page 4

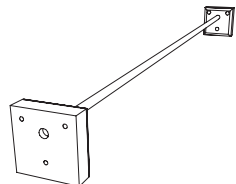
	Model	Size	Description	Weight	List Price	
					Oak	Maple
	SD1236MGVS	3/4" T x 12" D x 36" W	Veneered magazine shelf	7	\$ 128	\$ 143
	SD1236MGMS	3/4" T x 12" D x 36" W	Metal magazine shelf	9	\$ 128	
	SD1236PBSS	3/4" T x 12" D x 36" W	Solid picture book wood shelf	16	\$ 125	\$ 140
	If metal Picture Book shelves are required, contact Customer Service for upcharge.					
	SD36NP	34 1/2" H x 34 7/8" W	Newspaper rod insert (5 rods per insert)	40	\$ 450	\$ 504
	SD1036BCSS	3/4" T x 10" D x 36" W	Solid standard wood shelf	7	\$ 65	\$ 73
	SD1236BCSS	3/4" T x 12" D x 36" W	Solid standard wood shelf	8	69	77
	SD1036BCMS	3/4" T x 10" D x 36" W	Standard metal shelf	5	\$ 46	
	SD1236BCMS	3/4" T x 12" D x 36" W	Standard metal shelf	6	58	
<ul style="list-style-type: none"> <li>• Call Customer Service for color options.</li> <li>• To order metal shelving units please add the suffix (-M) at the end of the wood shelving model number.</li> </ul>						
	SD36HB	3" H x 3" D x 36" W	Hanging bag rack	8	\$ 130	

# Sherwood Accessories

for specifications, please see page 3 • for ordering information, please see page 4

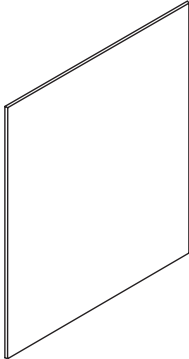
	Model	Size	Description	List Price	
				Oak	Maple
<b>Veneer Back Panels</b>					
	SD3036BPSVB	30" H x 1/4" D x 36" W	S/F Veneer back panel	\$ 65	\$ 73
	SD3636BPSVB	36" H x 1/4" D x 36" W	S/F Veneer back panel	73	82
	SD4236BPSVB	42" H x 1/4" D x 36" W	S/F Veneer back panel	85	95
	SD4836BPSVB	48" H x 1/4" D x 36" W	S/F Veneer back panel	88	99
	SD6036BPSVB	60" H x 1/4" D x 36" W	S/F Veneer back panel	134	150
	SD7236BPSVB	72" H x 1/4" D x 36" W	S/F Veneer back panel	138	155
	SD8236BPSVB	82" H x 1/4" D x 36" W	S/F Veneer back panel	141	158
	SD3036BPDVB	30" H x 1/4" D x 36" W	D/F Veneer back panel	\$ 73	\$ 82
	SD3636BPDVB	36" H x 1/4" D x 36" W	D/F Veneer back panel	91	102
	SD4236BPDVB	42" H x 1/4" D x 36" W	D/F Veneer back panel	93	104
	SD4836BPDVB	48" H x 1/4" D x 36" W	D/F Veneer back panel	95	106
	SD6036BPDVB	60" H x 1/4" D x 36" W	D/F Veneer back panel	142	159
	SD7236BPDVB	72" H x 1/4" D x 36" W	D/F Veneer back panel	146	164
	SD8236BPDVB	82" H x 1/4" D x 36" W	D/F Veneer back panel	149	167

## Melamine Back Panels

For use with single-faced and double-faced.

SD3036BPSMB	30" H x 1/4" D x 36" W	S/F Melamine back panel	\$ 58
SD3636BPSMB	36" H x 1/4" D x 36" W	S/F Melamine back panel	73
SD4236BPSMB	42" H x 1/4" D x 36" W	S/F Melamine back panel	75
SD4836BPSMB	48" H x 1/4" D x 36" W	S/F Melamine back panel	78
SD6036BPSMB	60" H x 1/4" D x 36" W	S/F Melamine back panel	104
SD7236BPSMB	72" H x 1/4" D x 36" W	S/F Melamine back panel	132
SD8236BPSMB	82" H x 1/4" D x 36" W	S/F Melamine back panel	136

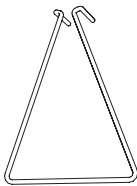

SDSHTBS	7 1/2" H x 6 3/8" D x 1 3/4" W	Hanging triangular book support	\$ 10
<ul style="list-style-type: none"> <li>• Book support ONLY. Does not include grooved shelf.</li> <li>• Nickel Plated</li> <li>• Shipping weight: 1 lb.</li> </ul>			



# Sherwood Accessories

for specifications, please see page 3 • for ordering information, please see page 4

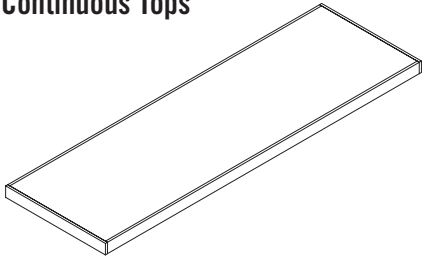
	Model	Size	Weight	List Price				
				¾" Standard Oak	¾" Standard Maple	1 ¼" Designer Edge Oak	1 ¼" Designer Edge Maple	
<b>Continuous Tops</b> 	SD1036CT	1 3/16" T x 36" W x 10" D	30	\$ 82	\$ 92	\$ 102	\$ 114	
	SD1072CT	1 3/16" T x 72" W x 10" D	60	146	164	183	205	
	SD10108CT	1 3/16" T x 108" W x 10" D	90	214	240	268	300	
	SD10144CT	1 3/16" T x 144" W x 10" D	120	276	309	345	386	
	SD10180CT	1 3/16" T x 180" W x 10" D	150	334	374	417	467	
	SD10216CT	1 3/16" T x 216" W x 10" D	180	390	437	488	547	
	SD10252CT	1 3/16" T x 252" W x 10" D	210	449	503	561	628	
	SD10288CT	1 3/16" T x 288" W x 10" D	240	510	571	638	715	
	<ul style="list-style-type: none"> <li>• Tops shall have 1/4" eased internal edge band.</li> <li>• If decorative edges are specified, use Designer Edge price.</li> </ul>	SD1236CT	1 3/16" T x 36" W x 12" D	31	\$ 85	\$ 95	\$ 106	\$ 119
		SD1272CT	1 3/16" T x 72" W x 12" D	62	152	170	190	213
SD12108CT		1 3/16" T x 108" W x 12" D	93	222	249	278	311	
SD12144CT		1 3/16" T x 144" W x 12" D	124	287	321	359	402	
SD12180CT		1 3/16" T x 180" W x 12" D	155	346	388	433	485	
SD12216CT		1 3/16" T x 216" W x 12" D	185	406	455	507	568	
SD12252CT		1 3/16" T x 252" W x 12" D	216	467	523	584	654	
SD12288CT		1 3/16" T x 288" W x 12" D	247	530	594	663	743	
	SD2036CT	1 3/16" T x 36" W x 20" D	60	\$ 103	\$ 115	\$ 129	\$ 144	
	SD2072CT	1 3/16" T x 72" W x 20" D	120	196	220	245	274	
	SD20108CT	1 3/16" T x 108" W x 20" D	180	285	319	356	399	
	SD20144CT	1 3/16" T x 144" W x 20" D	240	370	414	463	519	
	SD20180CT	1 3/16" T x 180" W x 20" D	300	490	549	612	685	
	SD20216CT	1 3/16" T x 216" W x 20" D	360	568	636	710	795	
	SD20252CT	1 3/16" T x 252" W x 20" D	420	649	727	811	908	
	SD20288CT	1 3/16" T x 288" W x 20" D	480	758	849	947	1,061	
	SD2436CT	1 3/16" T x 36" W x 24" D	62	\$ 107	\$ 120	\$ 134	\$ 150	
	SD2472CT	1 3/16" T x 72" W x 24" D	124	204	228	255	286	
	SD24108CT	1 3/16" T x 108" W x 24" D	185	296	332	370	414	
	SD24144CT	1 3/16" T x 144" W x 24" D	247	386	432	482	540	
	SD24180CT	1 3/16" T x 180" W x 24" D	309	510	571	637	713	
	SD24216CT	1 3/16" T x 216" W x 24" D	371	591	662	739	828	
	SD24252CT	1 3/16" T x 252" W x 24" D	433	675	756	844	945	
	SD24288CT	1 3/16" T x 288" W x 24" D	494	789	884	986	1,104	

# Sherwood Accessories

for specifications, please see page 3 • for ordering information, please see page 4

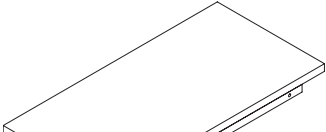
	Model	Size	Weight	List Price	
				Oak	Maple
<b>Double-Faced Top Fillers</b>					
	SD1020TF	1" T x 20" W x 10" D	5	\$ 88	\$ 99
	SD1024TF	1" T x 24" W x 10" D	6	94	105
	SD1220TF	1" T x 20" W x 12" D	8	102	114
	SD1224TF	1" T x 24" W x 12" D	9	107	120

## Face Fillers

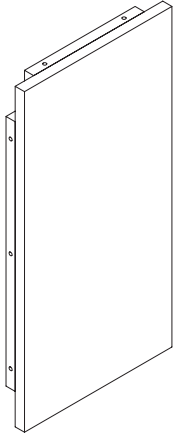

SD3010FF	1" T x 10" W x 30" D	12	\$ 70	\$ 78
SD3012FF	1" T x 12" W x 30" D	12	72	81
SD3610FF	1" T x 10" W x 36" D	14	81	91
SD3612FF	1" T x 12" W x 36" D	14	83	93
SD4210FF	1" T x 10" W x 42" D	16	89	100
SD4212FF	1" T x 12" W x 42" D	16	91	102
SD4810FF	1" T x 10" W x 48" D	18	98	110
SD4812FF	1" T x 12" W x 48" D	18	100	112
SD6010FF	1" T x 10" W x 60" D	21	117	131
SD6012FF	1" T x 12" W x 60" D	21	119	133
SD7210FF	1" T x 10" W x 72" D	23	139	156
SD7212FF	1" T x 12" W x 72" D	23	141	158
SD8210FF	1" T x 10" W x 82" D	26	143	160
SD8212FF	1" T x 12" W x 82" D	26	145	162

## Single-Faced Corner Fillers

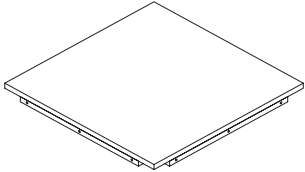

	Model	Size	Weight	List Price	
				Oak	Maple
SD1010CF	1" T x 10" W x 10" D	3	\$ 59	\$ 66	
SD1012CF	1" T x 12" W x 10" D	4	65	73	
SD1212CF	1" T x 12" W x 12" D	6	62	69	
SD1216CF	1" T x 16" W x 12" D	7	67	75	

# Sherwood Index

SD3010BC-A .....	5	SD4820BC-A .....	7	SD8220BC-S .....	8	SD24216CT .....	18
SD3010BC-S .....	5	SD4820BC-S .....	7	SD8224BC-A .....	8	SD24252CT .....	18
SD3012BC-A .....	5	SD4824BC-A .....	7	SD8224BC-S .....	8	SD24288CT .....	18
SD3012PB-A .....	13	SD4824BC-S .....	7	SD8224MG-A .....	12	SD2436CT .....	18
SD3012PB-S .....	13	SD4824MG-A .....	11	SD8224MG-S .....	12	SD2472CT .....	18
SD3020BC-A .....	7	SD4824MG-S .....	11			SD3010FF .....	19
SD3020BC-S .....	7	SD4824PB-A .....	14			SD3012FF .....	19
SD3024BC-A .....	7	SD4824PB-S .....	14			SD3036BPDMB .....	17
SD3024BC-S .....	7	SD6010BC-A .....	6			SD3036BPDVB .....	17
SD3024PB-A .....	14	SD6010BC-S .....	6			SD3036BPSMB .....	17
SD3024PB-S .....	14	SD6012BC-A .....	6			SD3036BPSVB .....	17
SD3610BC-A .....	5	SD6012BC-S .....	6			SD3610FF .....	19
SD3610BC-S .....	5	SD6012MG-A .....	9			SD3612FF .....	19
SD3612BC-A .....	5	SD6012MG-S .....	9			SD3636BPDMB .....	17
SD3612BC-S .....	5	SD6012PB-A .....	13			SD3636BPDVB .....	17
SD3612MG-A .....	9	SD6012PB-S .....	13			SD3636BPSMB .....	17
SD3612MG-S .....	9	SD6020BC-A .....	8			SD3636BPSVB .....	17
SD3612PB-A .....	13	SD6020BC-S .....	8			SD36HB .....	16
SD3612PB-S .....	13	SD6024BC-A .....	8			SD36NP .....	16
SD3620BC-A .....	7	SD6024BC-S .....	8			SD4210FF .....	19
SD3620BC-S .....	7	SD6024MG-A .....	12			SD4212FF .....	19
SD3624BC-A .....	7	SD6024MG-S .....	12			SD4236BPDMB .....	17
SD3624BC-S .....	7	SD6024PB-A .....	15			SD4236BPDVB .....	17
SD3624MG-A .....	11	SD6024PB-S .....	15			SD4236BPSMB .....	17
SD3624MG-S .....	11	SD6032PB-A .....	15			SD4236BPSVB .....	17
SD3624PB-A .....	14	SD6032PB-S .....	15			SD4810FF .....	19
SD3624PB-S .....	14	SD7210BC-A .....	6			SD4812FF .....	19
SD4210BC-A .....	5	SD7210BC-S .....	6			SD4836BPDMB .....	17
SD4210BC-S .....	5	SD7212BC-A .....	6			SD4836BPDVB .....	17
SD4212BC-A .....	5	SD7212BC-S .....	6			SD4836BPSMB .....	17
SD4212BC-S .....	5	SD7212MG-A .....	10			SD4836BPSVB .....	17
SD4212MG-A .....	9	SD7212MG-S .....	10			SD6010FF .....	19
SD4212MG-S .....	9	SD7212PB-A .....	13			SD6012FF .....	19
SD4212PB-A .....	13	SD7212PB-S .....	13			SD6036BPDMB .....	17
SD4212PB-S .....	13	SD7220BC-A .....	8			SD6036BPDVB .....	17
SD4220BC-A .....	7	SD7220BC-S .....	8			SD6036BPSMB .....	17
SD4220BC-S .....	7	SD7224BC-A .....	8			SD6036BPSVB .....	17
SD4224BC-A .....	7	SD7224BC-S .....	8			SD7210FF .....	19
SD4224BC-S .....	7	SD7224MG-A .....	12			SD7212FF .....	19
SD4224MG-A .....	11	SD7224MG-S .....	12			SD7236BPDMB .....	17
SD4224MG-S .....	11	SD7224PB-A .....	15			SD7236BPDVB .....	17
SD4224PB-A .....	14	SD7224PB-S .....	15			SD7236BPSMB .....	17
SD4224PB-S .....	14	SD7232PB-A .....	15			SD7236BPSVB .....	17
SD4810BC-A .....	5	SD7232PB-S .....	15			SD8210FF .....	19
SD4810BC-S .....	5	SD8210BC-A .....	6			SD8212FF .....	19
SD4812BC-A .....	5	SD8210BC-S .....	6			SD8236BPDMB .....	17
SD4812BC-S .....	5	SD8212BC-A .....	6			SD8236BPDVB .....	17
SD4812MG-A .....	9	SD8212BC-S .....	6			SD8236BPSMB .....	17
SD4812MG-S .....	9	SD8212MG-A .....	10			SD8236BPSVB .....	17
SD4812PB-A .....	13	SD8212MG-S .....	10			SDSHTBS .....	17
SD4812PB-S .....	13	SD8220BC-A .....	8				

## Accessories

SD10108CT .....	18
SD10144CT .....	18
SD10180CT .....	18
SD10216CT .....	18
SD10252CT .....	18
SD10288CT .....	18
SD1010CF .....	18
SD1012CF .....	18
SD1020TF .....	19
SD1024TF .....	19
SD1036BCMS .....	16
SD1036BCSS .....	16
SD1036CT .....	18
SD1036PBSS .....	16
SD1072CT .....	18
SD12108CT .....	18
SD12144CT .....	18
SD12180CT .....	18
SD12216CT .....	18
SD12252CT .....	18
SD12288CT .....	18
SD1212CF .....	18
SD1216CF .....	18
SD1220TF .....	19
SD1224TF .....	19
SD1236BCMS .....	16
SD1236BCSS .....	16
SD1236CT .....	18
SD1236MGMS .....	16
SD1236MGVS .....	16
SD1236PBSS .....	16
SD1272CT .....	18
SD1636PBSS .....	16
SD20108CT .....	18
SD20144CT .....	18
SD20180CT .....	18
SD20216CT .....	18
SD20252CT .....	18
SD20288CT .....	18
SD2036CT .....	18
SD2072CT .....	18
SD24108CT .....	18
SD24144CT .....	18
SD24180CT .....	18